

6Bit Digital Electronic Clock DIY Kit

1.Introduction:

It is a 6Bit Digital Electronic Clock DIY Kit. It integrates six functions: time, alarm clock, calibration, countdown, stopwatch and counter. User can set alarm as your needs.It is easy to operate, beautiful design, very suitable for home or office environment.

2.Feature:

- 1>.Time Display/Calibrate:Display time and support calibration.
- 2>.Alarm Clock: Built-in alarm clocks. Users can ON or OFF according needs.
- 3>.Countdown:Set the countdown as required. Maximum time is 99:59:59.
- 4>.Stopwatch: Record minutes and seconds after start.Maximum time is 99:59:59.
- 5>.Counter:It can also serve as a counter, with a counting range of 0~999999
- 6>.DIY Hand Soldering. It's a DIY kit which comes with various components. User need to install each component by hand. It not only can exercise and improve soldering skills, but also increase the interest in electronic technology. Great for electronics hobbyists, beginners, school and home education.

3.Parameter:

- 1>.Item name: 6Bit Digital Electronic Clock DIY Kit
- 2>.Work voltage:DC 5V-12V
- 3>.Display color:Red
- 4>.Work Temperature:-20℃~85℃
- 5>.Work Humidity:5%~95%RH
- 6>.Size(Installed):100*55*12mm

4.Component listing:

NO.	Component Name	PCB Marker	Parameter	QTY
1	Metal Film Resistor	R1,R2,R11-R17	1Kohm	9
2	Metal Film Resistor	R4-R10	220ohm	7
3	Metal Film Resistor	R3	10Kohm	1
4	Metal Film Resistor	R18	5.1Kohm	1
5	Ceramic Capacitor	C1,C4	0.1uF 104	2
6	Ceramic Capacitor	C5,C6	30pF	2
7	Electrolytic Capacitor	C2,C3	10uF/25V	2
8	Active Buzzer	SPEAKER	5V	1
9	S8550 Transistor	Q1-Q7	TO-92	7
10	78L05 Voltage Regulator	78L05	TO-92	1
11	Crystal Oscillator	Y1	12MHz	1
12	Button	S1-S3	6*6mm	3
13	AT89C2051 Controller	U1	DIP-20	1
14	IC Socket	U1	DIP-20	1
15	Red LED	LED1-LED4	3mm	4
16	0.36in 2Bit Red Digital Tube	SMG1-SMG3	Red	3
17	Blue KF-301-2P Screw Terminal	J1	5.08mm	1
18	White XH2.54mm-2P Socket	J2,J3	2.54mm	2
19	DC-005 Power Socket	5-12V		1
20	USB Power Wire		100cm	1
21	PCB		100*55*1.6mm	1

Note:Users can complete the installation according to the PCB silk screen and component list.

5.Set Method:

- 1>.Button Description: S1 is Function SET Button, S2 is Function Select Button, S3 is Add Value Button.
- 2>.Operating Instructions: Click S1 Button to enter the parameter setting state. Save and exit the setting mode when pressed for the 6th time. Or keep press S1 button 2second to save and exit.
- 3>.**Display Time:** Default display 10:10:00 after power ON.

4>.Calibrate Time:

- 4.1>.Click S1 at the 1st time to Calibrate Display Time.
- 4.2>.Then display flashes automatically.
- 4.3>.Click S2 to increase value 1 for hour bit. Click S3 to increase value 1 for minute. Note:

Decreasing parameters value is not supported. It turns to 0 if more then 59.

5>.Alarm Clock:

- 5.1>.Click S1 at the 2nd time to set Alarm Clock.
- 5.2>.Then display flashes automatically and display 22:10:00 and 4 LED keep ON.
- 5.3>.Click S2 to increase value 1 for hour bit. Click S3 to increase value 1 for minute. Second cannot be changed.
- 5.4>.It means turn OFF Alarm Clock function if display '--:--:--'.
- 5.5>.Alarm is a buzzer that lasts for 3 seconds.

6>.Countdown:

- 6.1>.Click S1 at the 3rd time to set Countdown.
- 6.2>.Default display 0. Click S2 to display more bit from low bit to high bit.
- 6.3>.Click S3 to increase value 1 for the highest bit. Note: Set the low value first, and then set the high value.
- 6.4>.Click S2 for the seventh time to start the countdown.
- 6.5>.Click S2 again to stop countdown and return to set mode.

7>.Stopwatch:

- 7.1>.Click S1 at the 4th time to set Stopwatch.
- 7.2>.Then display 00:00:00 and 4 LED keep ON.
- 7.3>.Click S2 button to start Stopwatch and click again to stop.
- 7.4>.Click S3 button to clear stopwatch time at stop status.

8>.Counter:

- 8.1>.Click S1 at the 5th time to set Counter.
- 8.2>.Then display 00:00:00.
- 8.3>.Click S2 to increase value 1.
- 8.4>.Click S3 button to clear counter time.

6.Auxiliary Functions:

- 1>.J3 Socket: It is a buzzer alarm output terminal. It can output high level signal when alarming.
- 2>.J2 Socket: It is the buzzer control port. User can input controller from another MCU or sensor to controller alarm.
- 3>.J1 KF-301-2P Terminal: Input work voltage.
- 4>.DC-005 Socket: Input work voltage.

7.Schematic:

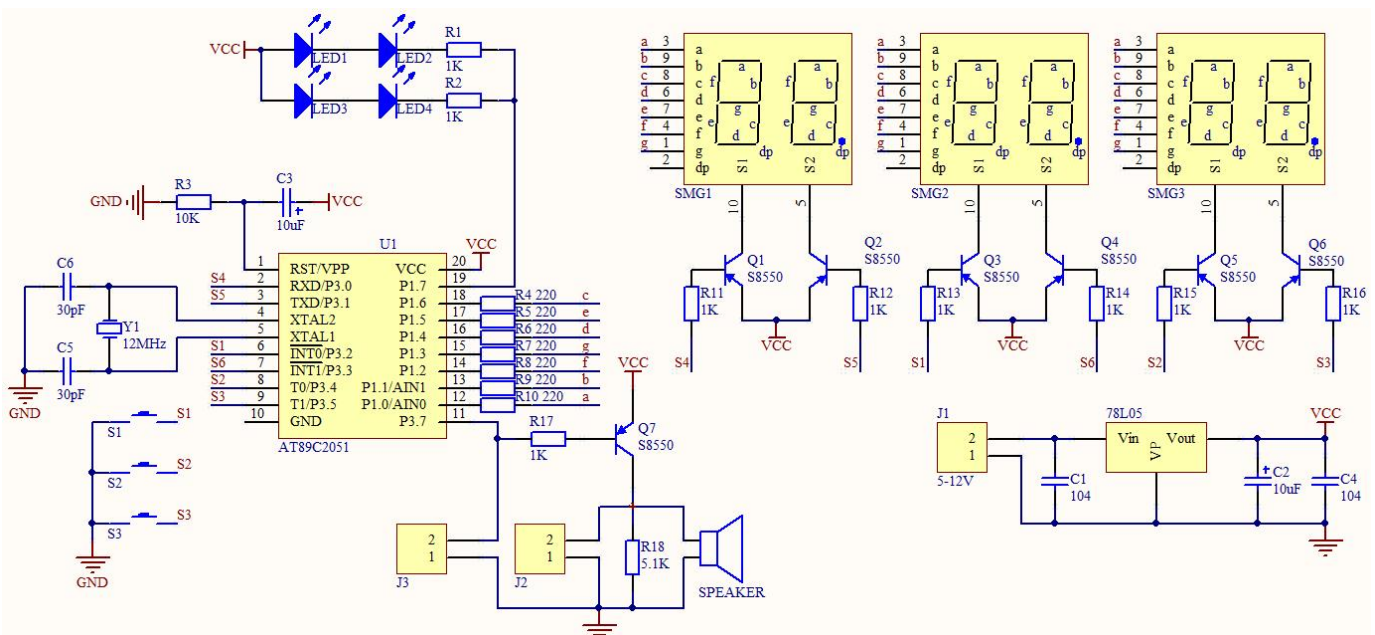

8.Note:

1>.It does not support the time memory function, so it needs to recalibrate the time every time the power is turned on.

2>.Users can choose any power supply mode.

9.Application:

1>.Practical at home

2>.Indoor display

3>.Simple appearance, easy office

4>.Wall decoration

10.Installation Tips:

1>.User needs to prepare the soldering tool at first.

2>.Please be patient until the installation is complete.

3>.The package is DIY kit.It need finish install by user.

4>.The soldering iron can't touch the components for a long time(1.0 second), otherwise it will damage the components.

5>.Pay attention to the positive and negative of the components.

6>.Strictly prohibit short circuit.

7>.Install complex components preferentially.

8>.Make sure all components are in right direction and right place.

9>.Please wear anti-static gloves or anti-static wristbands when installing electronic components.

10>.It is strongly recommended to read the installation manual before starting installation!!!

11.Installation Steps(Please be patient install!!!):

1>.Step 1: Install 9pcs 1Kohm Metal Film Resistor at R1,R2,R11-R17.

2>.Step 2: Install 7pcs 220ohm Metal Film Resistor at R4-R10.

3>.Step 3: Install 1pcs 10Kohm Metal Film Resistor at R3.

4>.Step 4: Install 1pcs 5.1Kohm Metal Film Resistor at R18.

5>.Step 5: Install 1pcs 12MHz Crystal Oscillator at Y1.

6>.Step 6: Install 1pcs DIP-20 IC Socket at U1. There is a gap mark on one end of the IC Socket and there is a gap mark on PCB silk screen where the IC Socket can place on. These two marks are corresponding to each other and are used to specify the installation direction of the IC Socket.

7>.Step 7: Install 2pcs 0.1uF 104 Ceramic Capacitor at C1,C4.

8>.Step 8: Install 2pcs 30pF Ceramic Capacitor at C5,C6.

9>.Step 9: Install 3pcs 6*6mm Button at S1-S3.

10>.Step 10: Install 2pcs White XH2.54mm-2P Socket at J2,J3.

11>.Step 11: Install 4pcs 3mm Red LED at LED1-LED4. Pay attention to the installation direction and the longer pin is positive pin and connect to ' + ' pad.

12>.Step 12: Install 7pcs TO-92 S8550 Transistor at Q1-Q7. Pay attention to the installation direction. The arc on the PCB corresponds to the arc of the components.

13>.Step 13: Install 1pcs Blue KF-301-2P Screw Terminal at J1.

14>.Step 14: Install 1pcs Active Buzzer at SPEAKER. Note: The marked ' + ' pin is positive pin and connect to ' + ' pad.

15>.Step 15: Install 1pcs TO-92 78L05 Voltage Regulator at 78L05. Pay attention to the installation direction. The arc on the PCB corresponds to the arc of the components.

16>.Step 16: Install 2pcs 10uF/25V Electrolytic Capacitor at C2,C3. Pay attention to distinguish between positive and negative. The Longer pin is positive pole and connect to ' + ' pad.

17>.Step 17: Install 3pcs 0.36in 2Bit Red Digital Tube at SMG1-SMG3. Pay attention to the installation direction of the decimal point.

18>.Step 18: Connect two pads at 'L1' by metal wire which cut from LED or resistor.

19>.Step 19: Install 1pcs DIP-20 AT89C2051 Controller at U1. There is a gap mark on one end of the IC and there is a gap mark on DIP-20 IC Socket where the IC can place on. These two marks are corresponding to each other and are used to specify the installation direction of the IC.

12.Install shown steps:

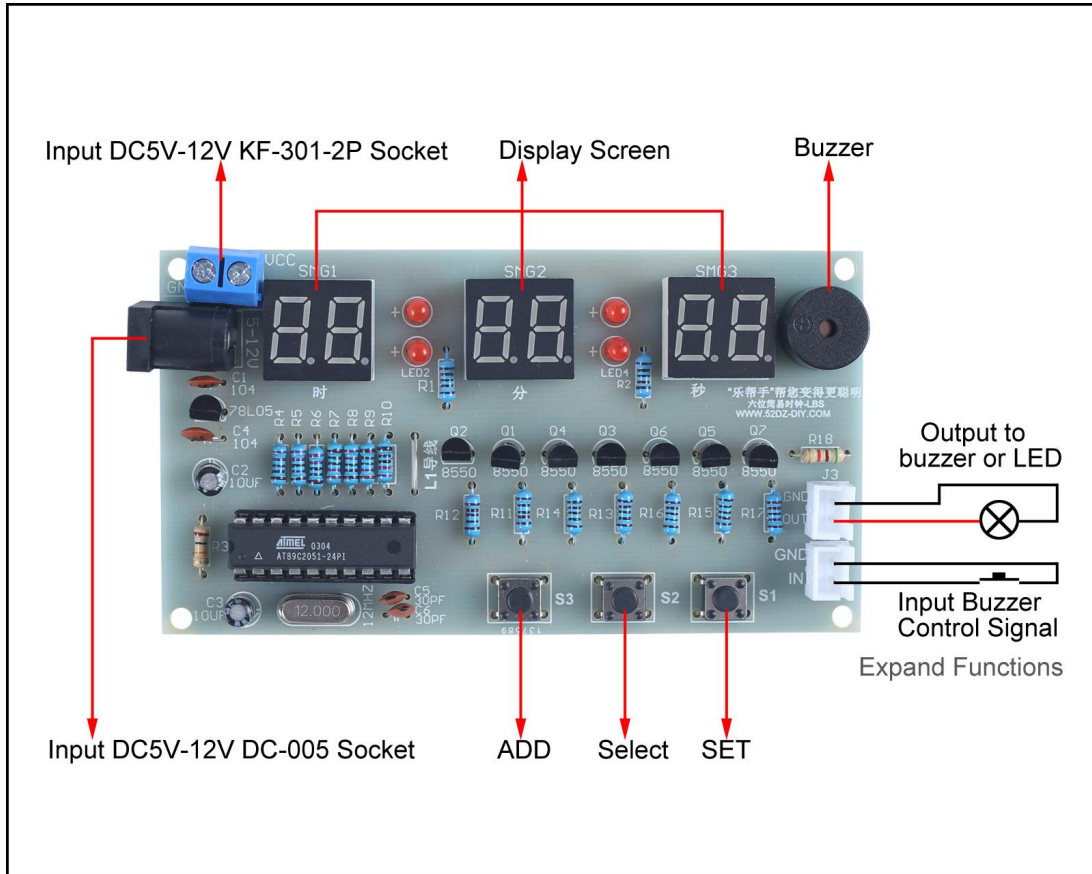

Step 1: Install 9pcs 1Kohm Metal Film Resistor at R1,R2,R11-R17.

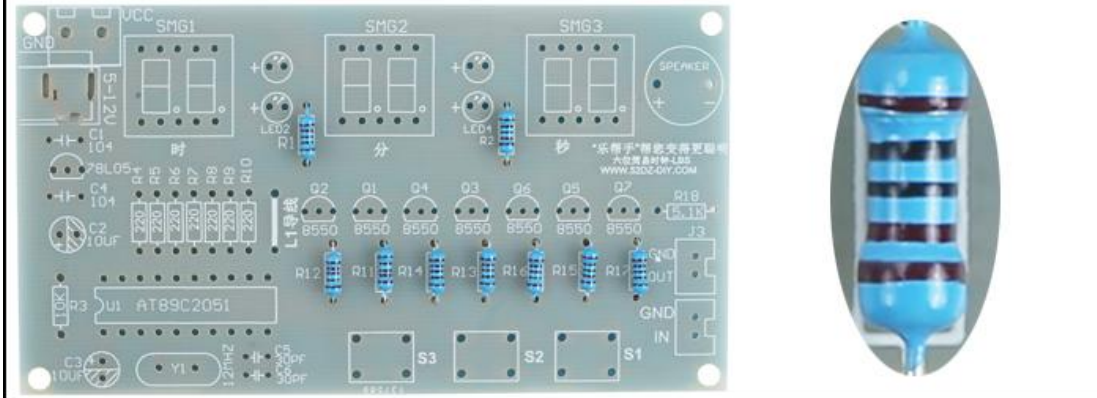

Step 2: Install 7pcs 220ohm Metal Film Resistor at R4-R10.

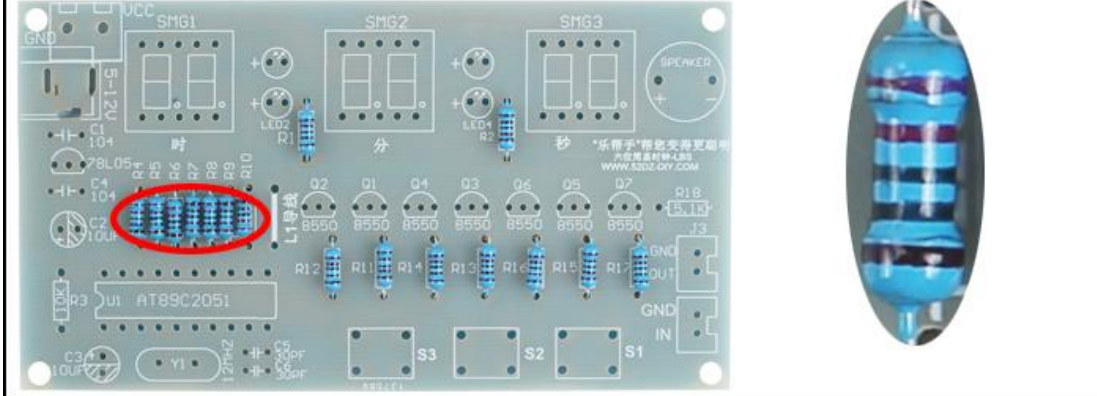

Step 3: Install 1pcs 10Kohm Metal Film Resistor at R3.

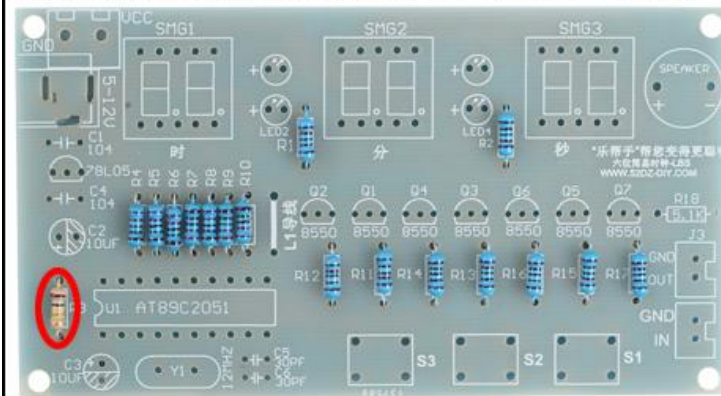

Step 4: Install 1pcs 5.1Kohm Metal Film Resistor at R18.

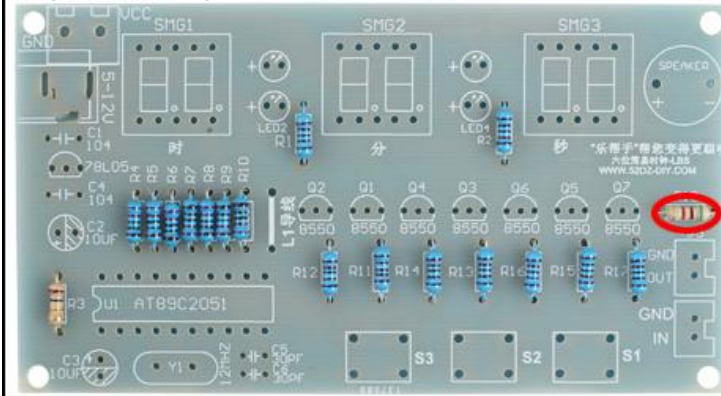

Step 5: Install 1pcs 12MHz Crystal Oscillator at Y1.

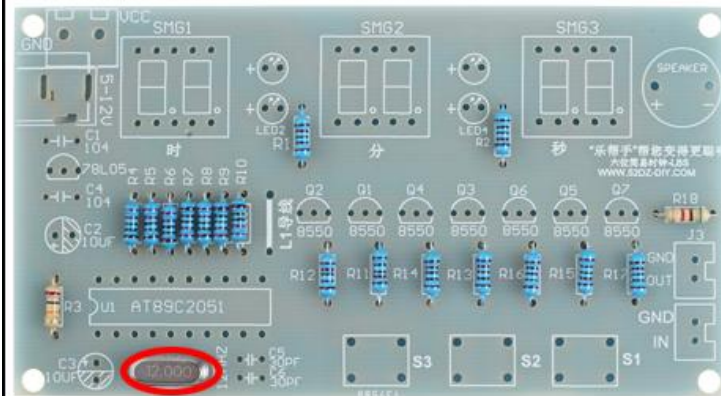

Step 6: Install 1pcs DIP-20 IC Socket at U1. There is a gap mark on one end of the IC Socket and there is a gap mark on PCB silk screen where the IC Socket can place on. These two marks are corresponding to each other and are used to specify the installation direction of the IC Socket.

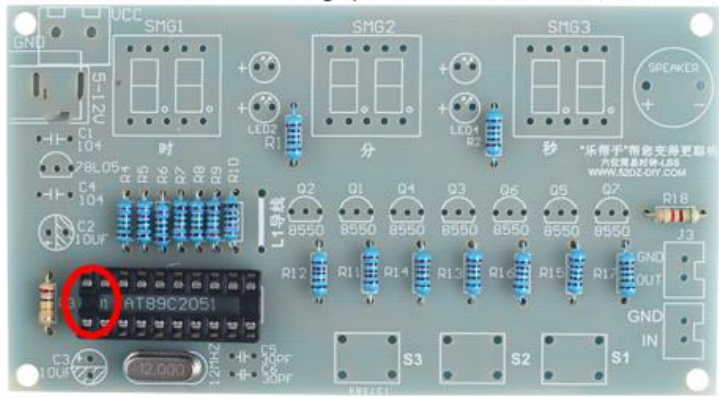

Step 7: Install 2pcs 0.1uF 104 Ceramic Capacitor at C1,C4.

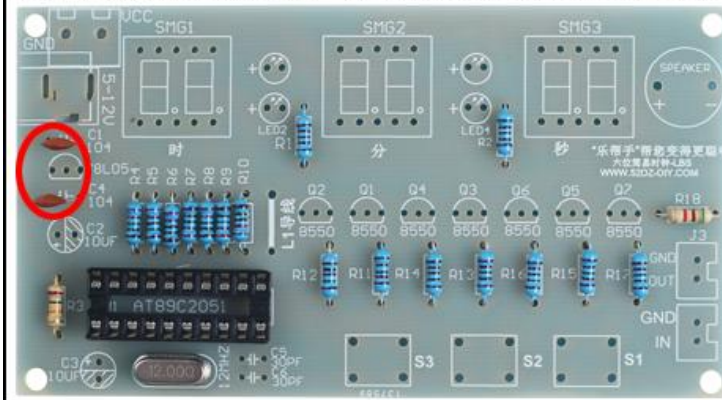

Step 8: Install 2pcs 30pF Ceramic Capacitor at C5,C6.

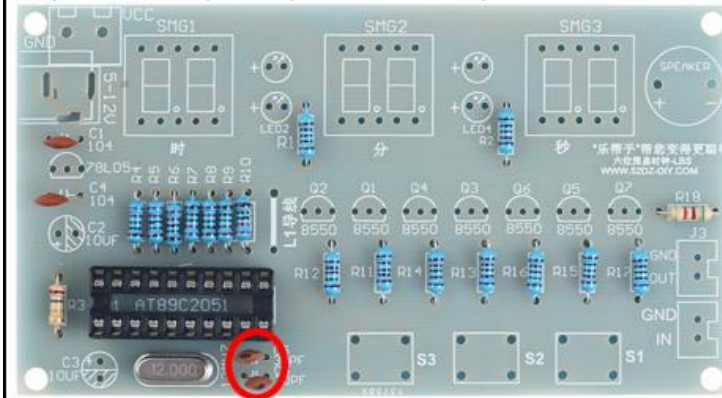

Step 9: Install 3pcs 6*6mm Button at S1-S3.

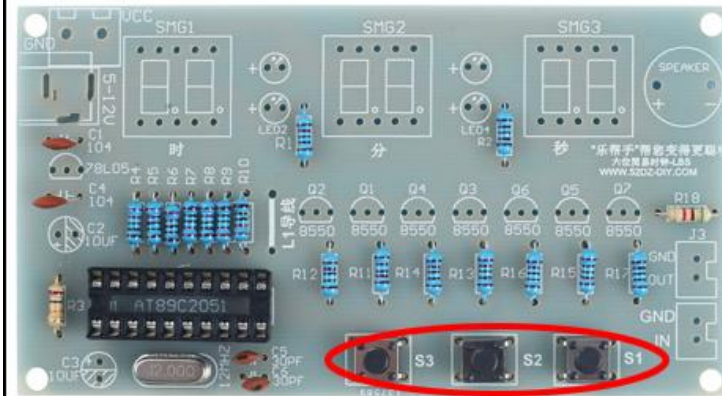

Step 10: Install 2pcs White XH2.54mm-2P Socket at J2,J3.

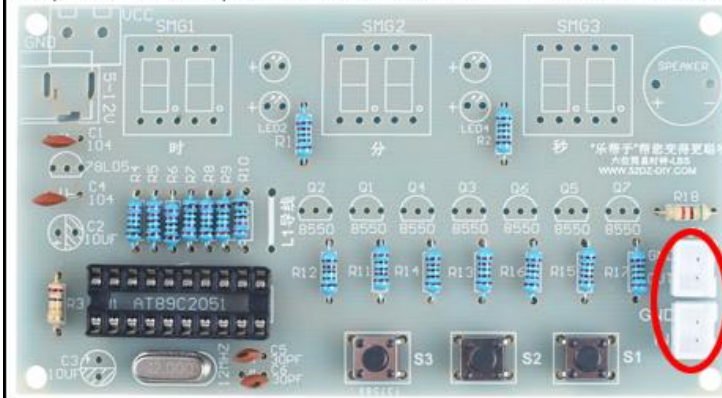

Step 11: Install 4pcs 3mm Red LED at LED1-LED4. Pay attention to the installation direction and the longer pin is positive pin and connect to '+' pad.

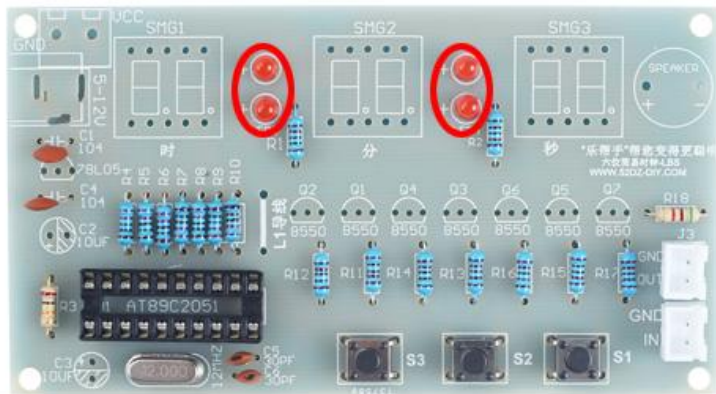

Step 12: Install 7pcs TO-92 S8550 Transistor at Q1-Q7. Pay attention to the installation direction. The arc on the PCB corresponds to the arc of the components.

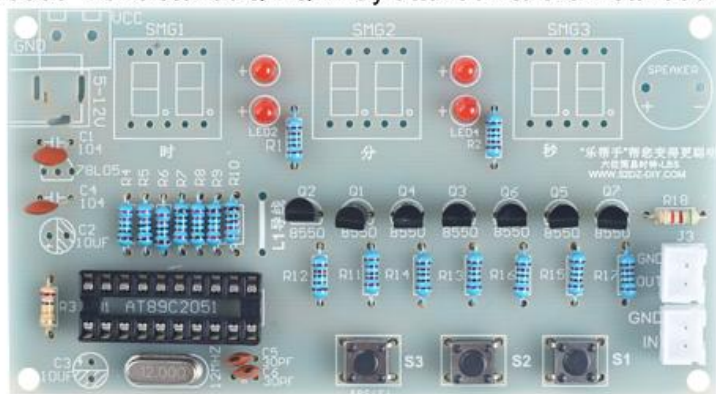

Step 13: Install 1pcs Blue KF-301-2P Screw Terminal at J1.

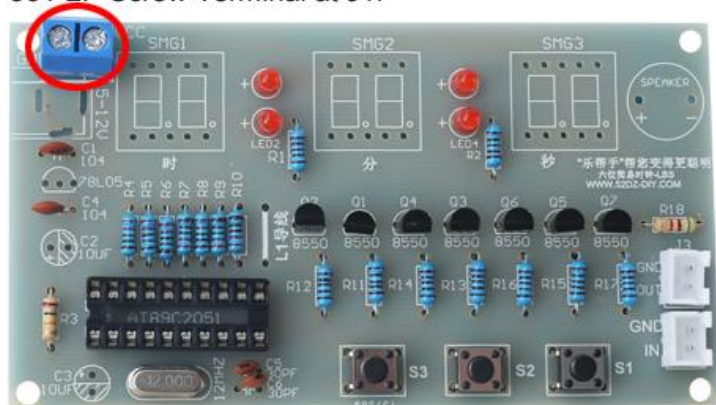

Step 14: Install 1pcs Active Buzzer at SPEAKER. Note: The marked '+' pin is positive pin and connect to '+' pad.

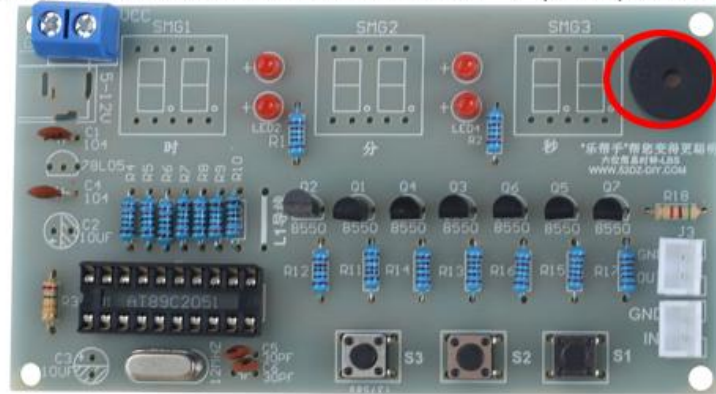

Step 15: Install 1pcs TO-92 78L05 Voltage Regulator at 78L05. Pay attention to the installation direction. The arc on the PCB corresponds to the arc of the components.

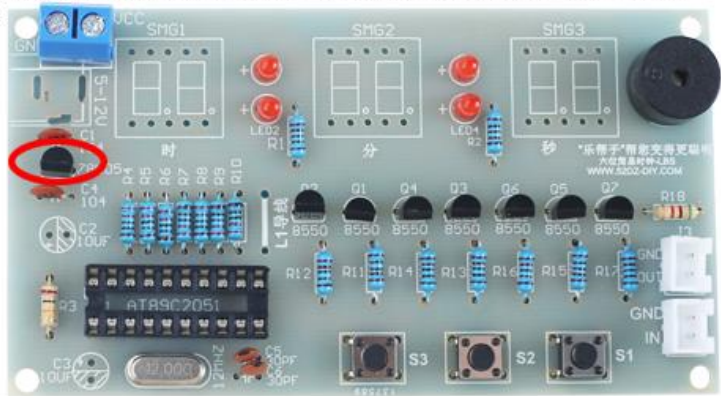

Step 16: Install 2pcs 10uF/25V Electrolytic Capacitor at C2,C3.

Pay attention to distinguish between positive and negative. The Longer pin is positive pole and connect to '+' pad.

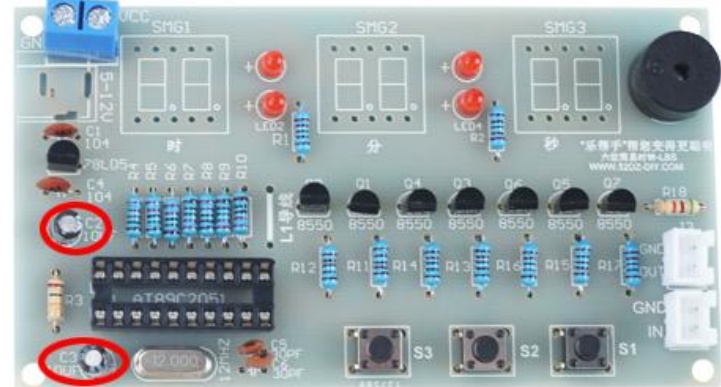

Step 17: Install 3pcs 0.36in 2Bit Red Digital Tube at SMG1-SMG3. Pay attention to the installation direction of the decimal point.

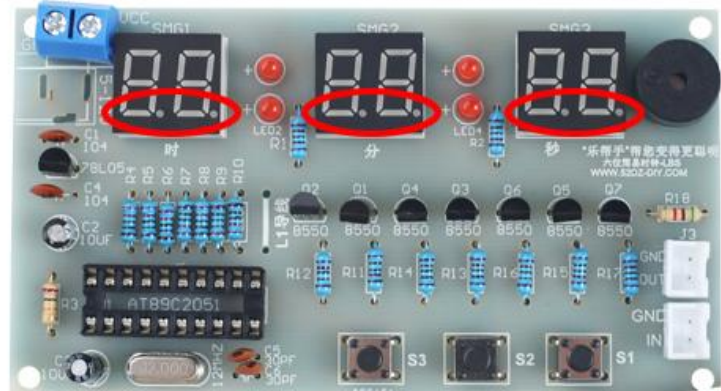

Step 18: Connect two pads at 'L1' by metal wire which cut from LED or resistor.

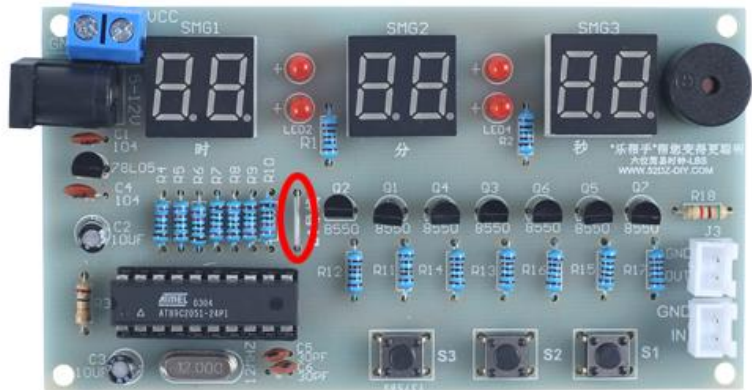

Step 19: Install 1pcs DIP-20 AT89C2051 Controller at U1. There is a gap mark on one end of the IC and there is a gap mark on DIP-20 IC Socket where the IC can place on. These two marks are corresponding to each other and are used to specify installation direction of the IC.

